

DIY FLOWER PRESS

YOU WILL
NEED

1. The Boredom Box
2. Scissors
3. 6 Paper Clips
4. Paper
5. Flower/Plant Cuttings

Step 1

Take an empty cardboard box, remove any tape and flatten like this

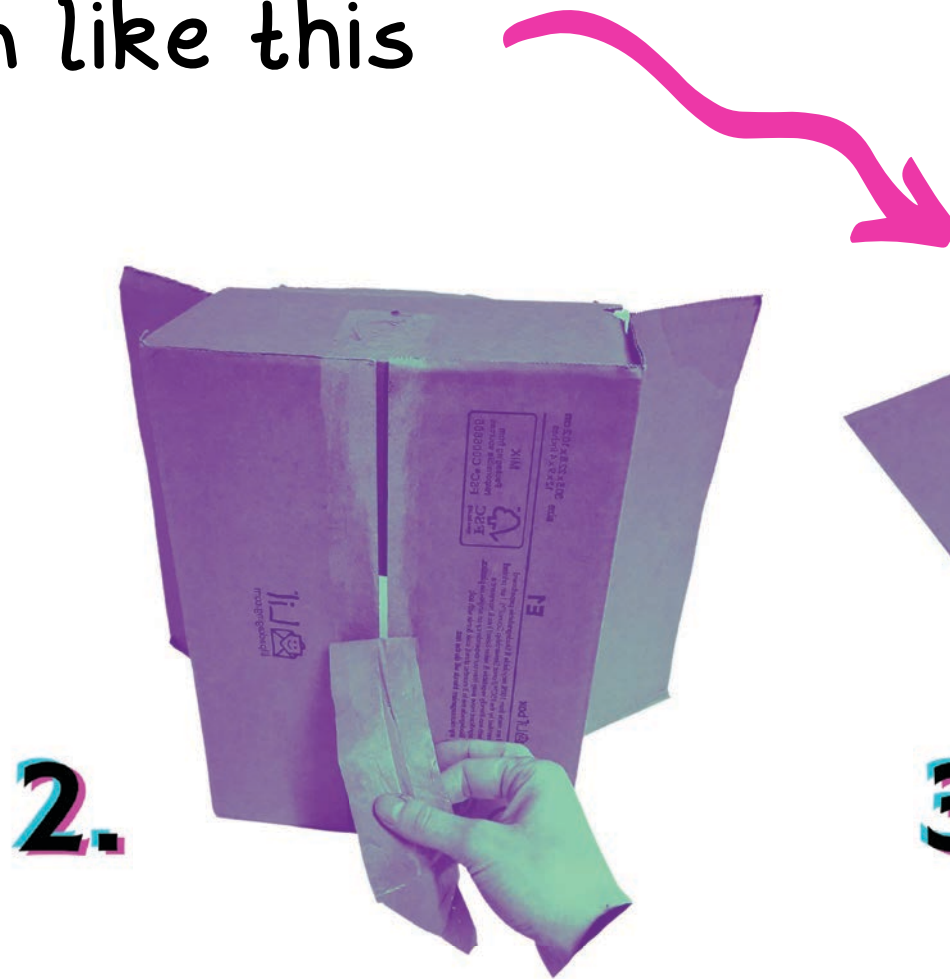
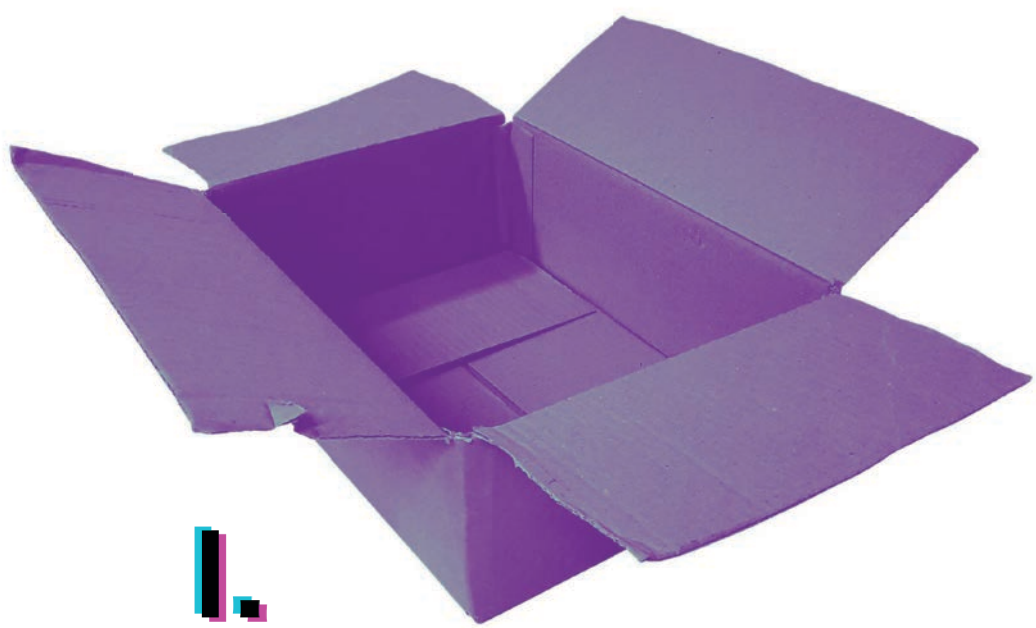

Use the scissors to cut along the folds of the box, creating 6 to 8 panels of equal size like this

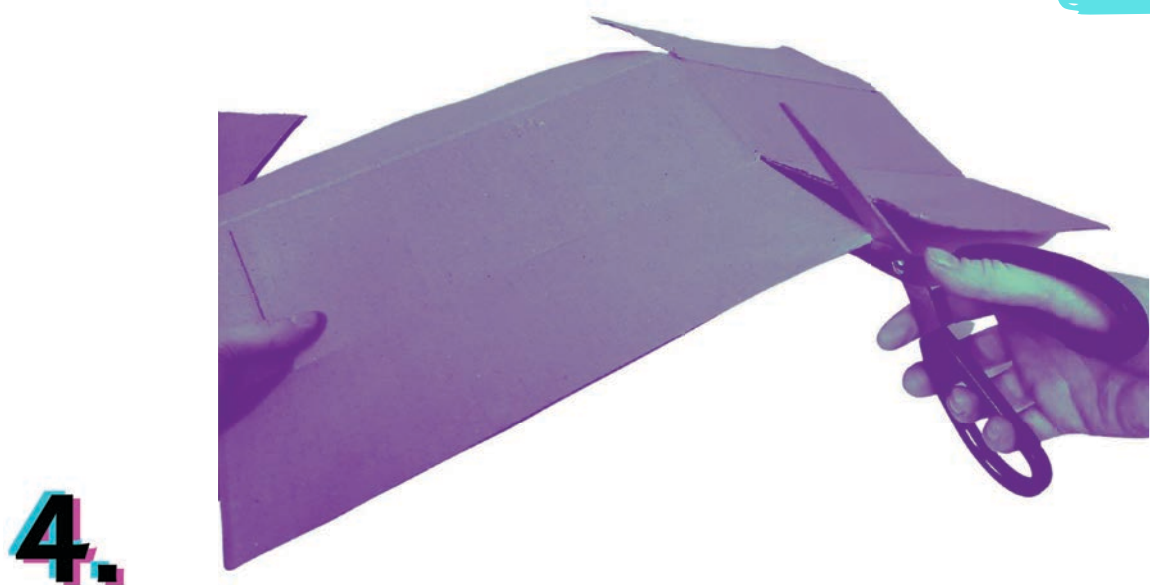

Step 2

You want to cut enough sheets of paper to fit inside the cardboard sheets that you've just cut. Make sure there are 2 sheets of paper (top and bottom) per cardboard layer like this

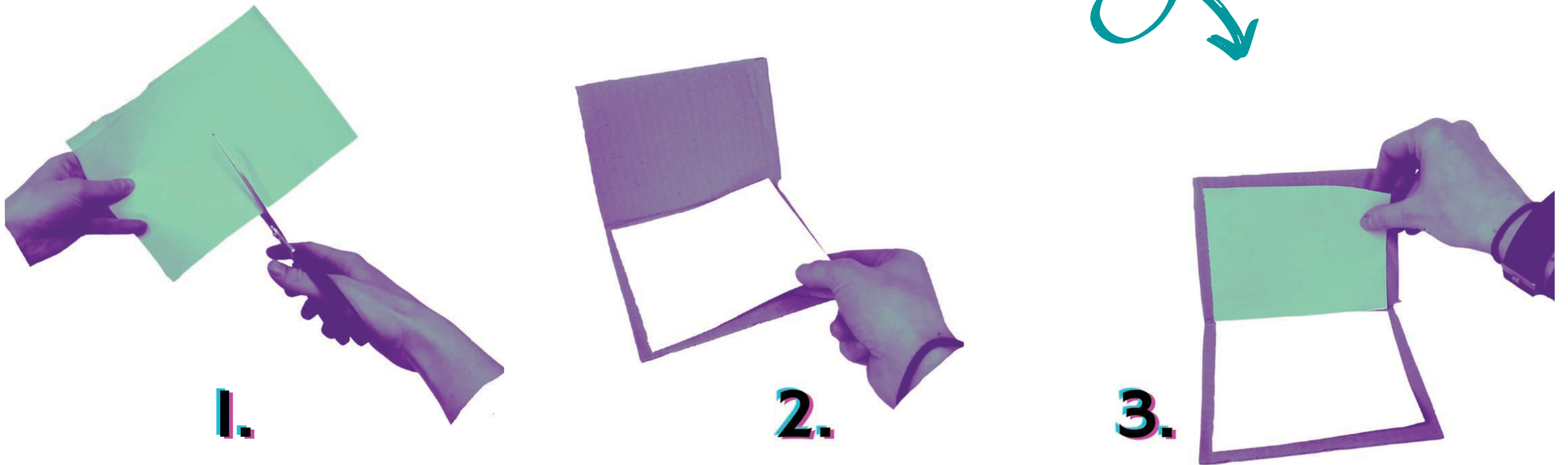

Step 3

Gather some flowers or plants that you wish to use in your flower press, trim the flowers to fit inside the boundary of the paper you cut in Step 2. Arrange how you would like the flowers to be displayed on the paper like this

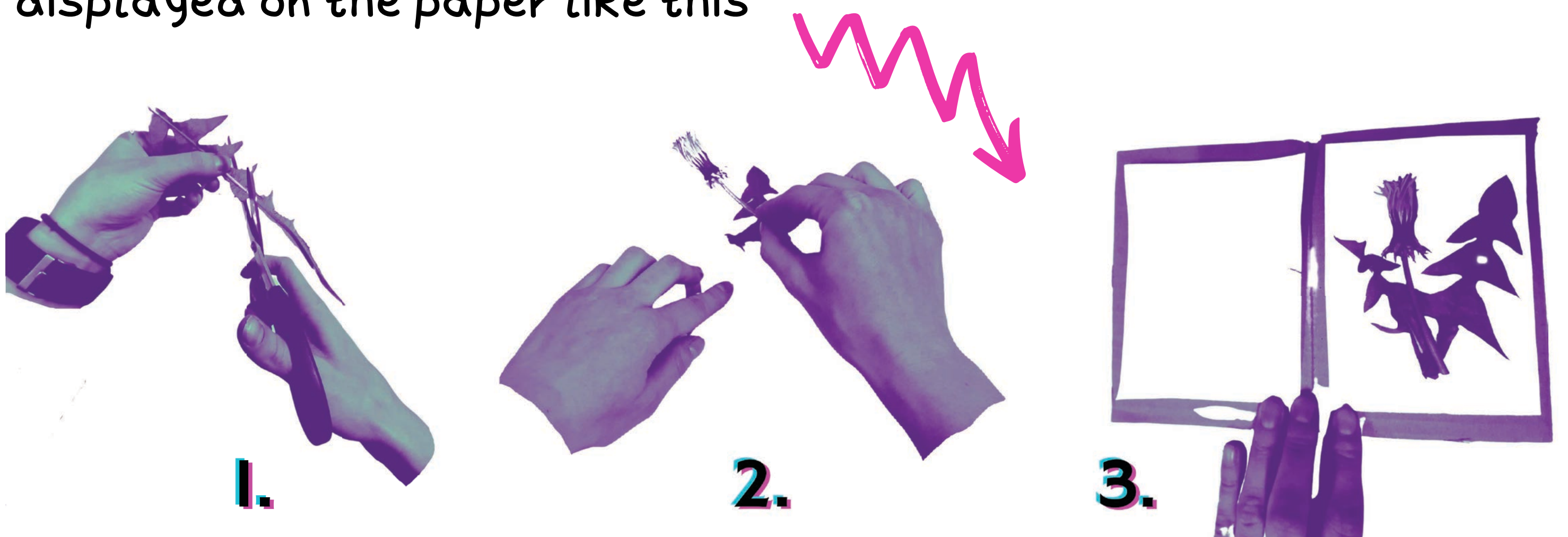

Step 4

Repeated the process in Step 3, until all the cardboard has flowers in between the layers, stack them upon each other like this and press down with your hands to compress the layers of cardboard together

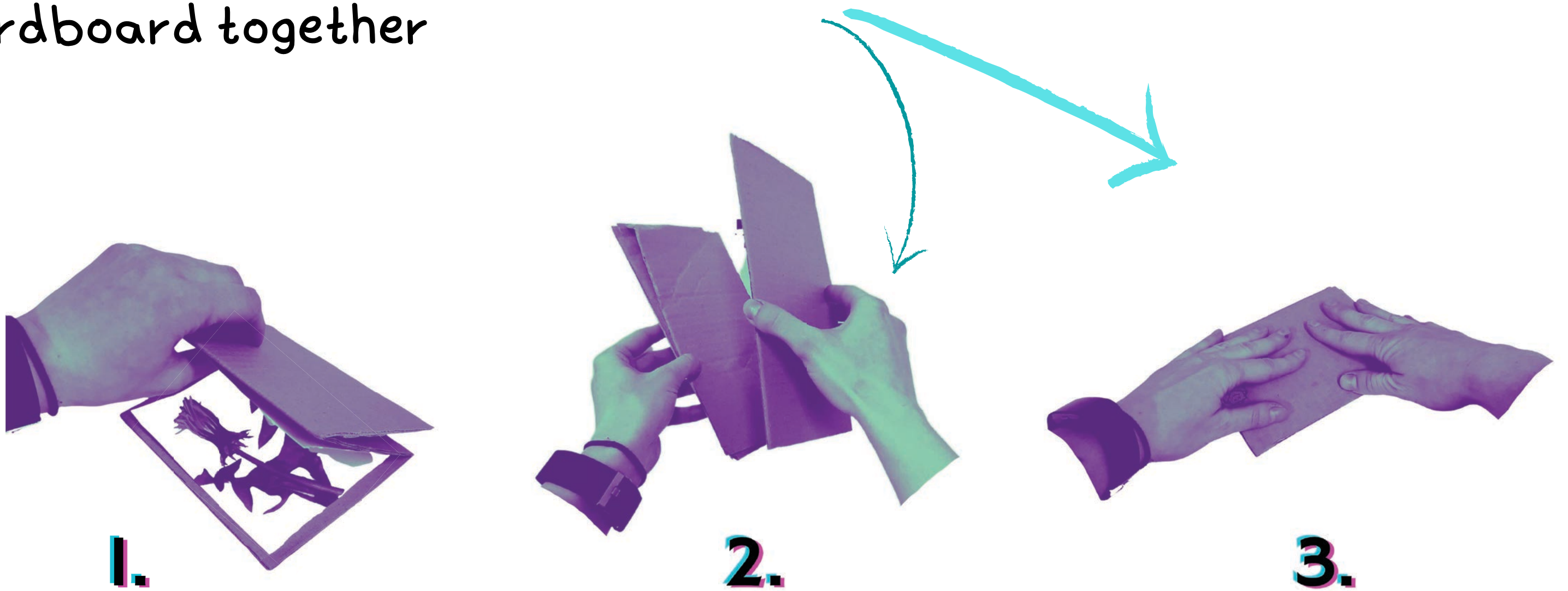

Step 5

Holding the layers of cardboard together with the paper and flowers in between, gather your paper clips and attach them around the edges like this



Step 6

When Step 5 has been completed leave the Flower Press in a dry, warm place for a couple of weeks to allow the flowers to dry out fully. You can always open it up to check on how the drying process is coming along. *Remember to reattach the cardboard and clips once you've given it a once over.*

Once it has completely dried out you can remove the flowers / plants from the Flower Press and create other things with them like framed art, you can gift it to someone or make decorative cards.

What's even more exciting is that you can reuse this Flower Press as many times as you'd like!

Voila!!

**Just like that you have your very own
Flower Press!**



MAKING SHAPES

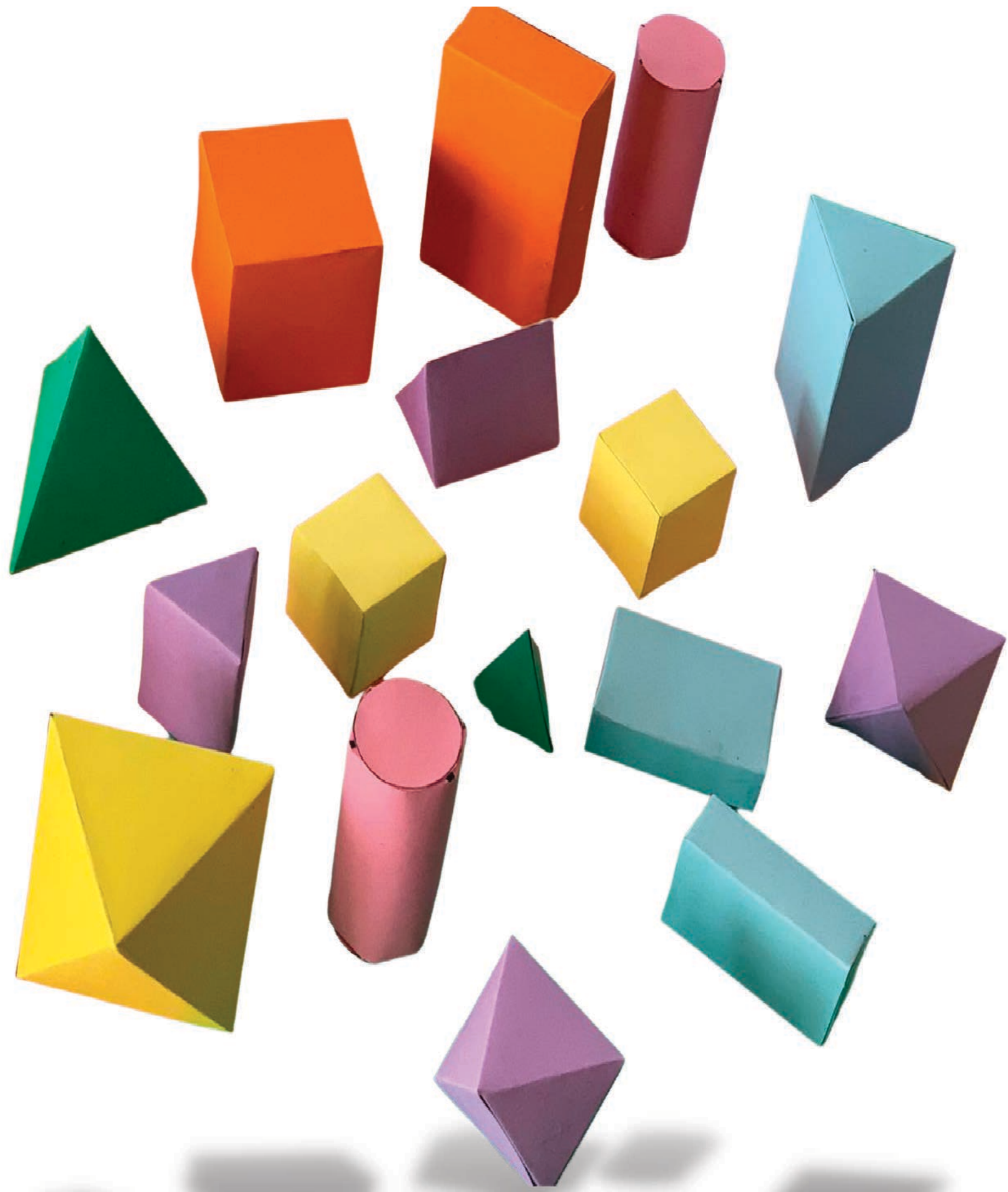

&

CREATIVE

CHARACTERS

YOU WILL NEED

1. **SCISSORS**
2. **GLUE STICK**
3. **SHAPE TEMPLATES**
4. **PIPE CLEANERS**
5. **GOOGLY EYES**

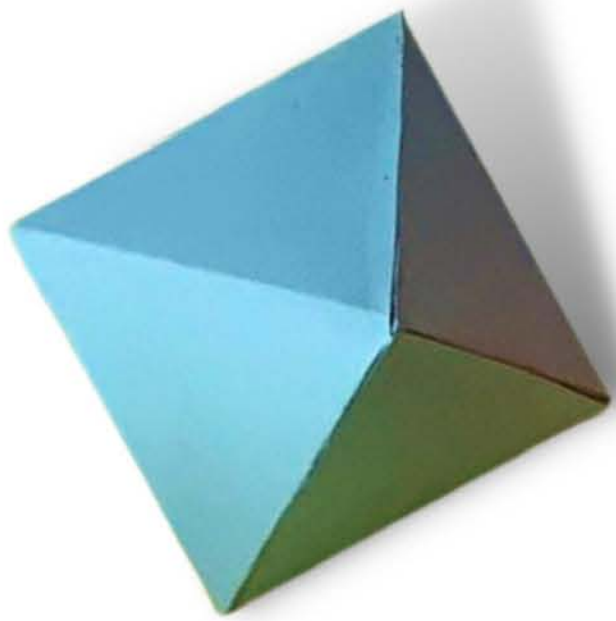
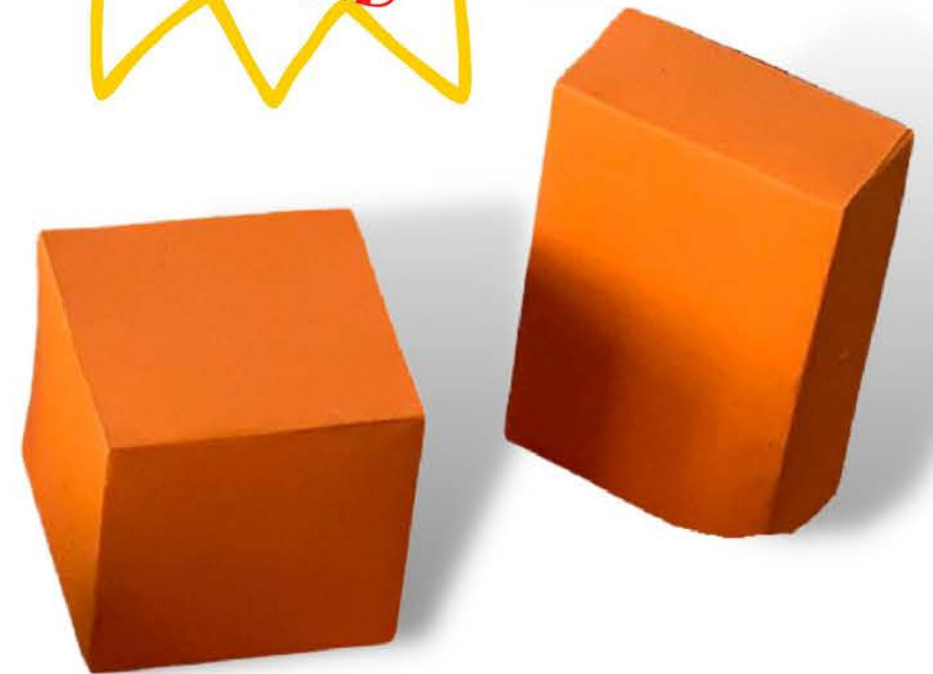

**GATHER YOUR MATERIALS:
SCISSORS, GLUE AND THE
SHAPE TEMPLATES.**

**CUT ALONG THE
SHAPE
TEMPLATE
UNTIL ALL CUT
LINES ARE GONE.**

FOLD

Cut

GLUE

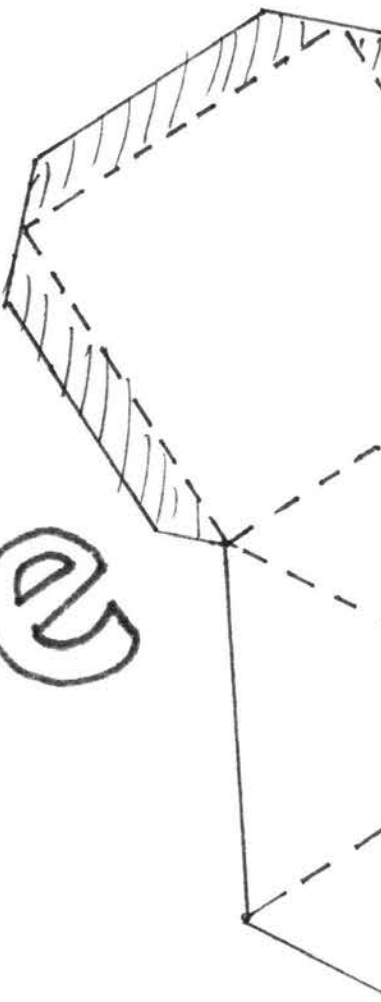

**THEN FOLD WHERE THERE ARE
FOLD LINES.**



**ONCE FOLDED, GRAB YOUR GLUE STICK AND GLUE
ALONG THE GLUE MARKINGS, ATTACHING THE PAPER
TOGETHER TO MAKE SHAPES.**

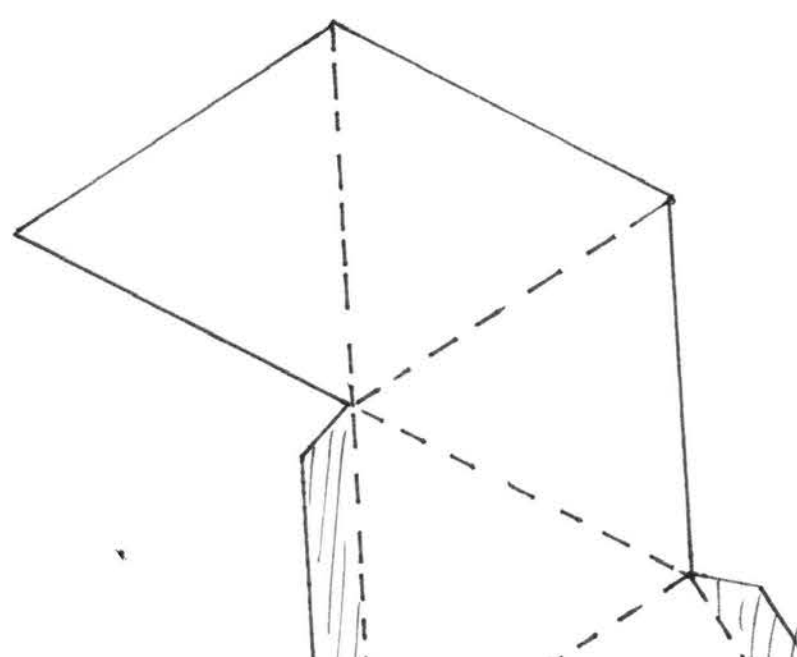

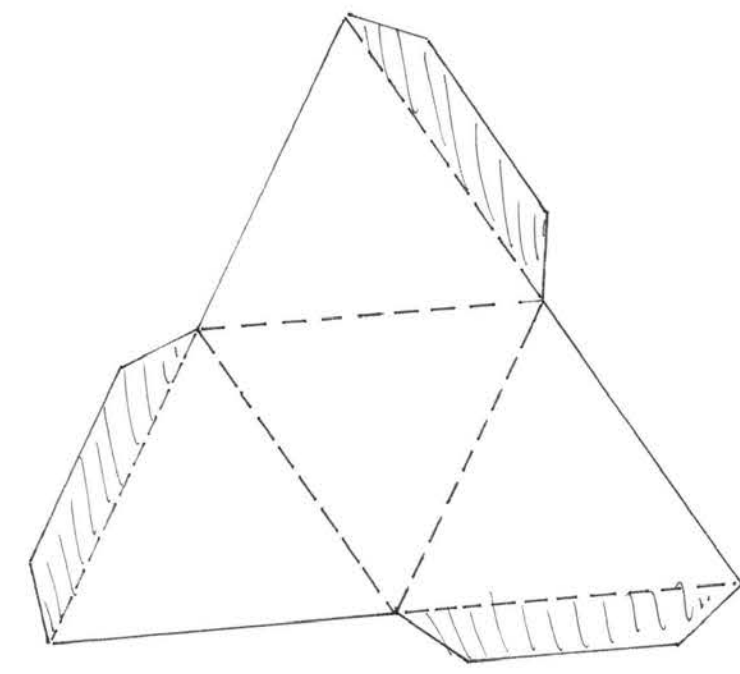
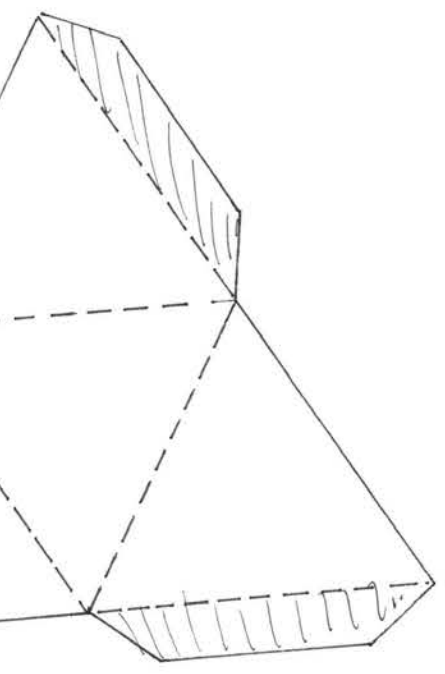

AFTER YOU'VE BUILT THE SHAPES ALLOW THEM TO DRY.

ONCE DRIED YOU CAN MAKE CREATIVE CHARACTERS WITH GOOGLY EYES AND PIPE CLEANERS. NAME YOUR CREATIONS AND FIND THEM A HOME AROUND YOUR HOUSE!

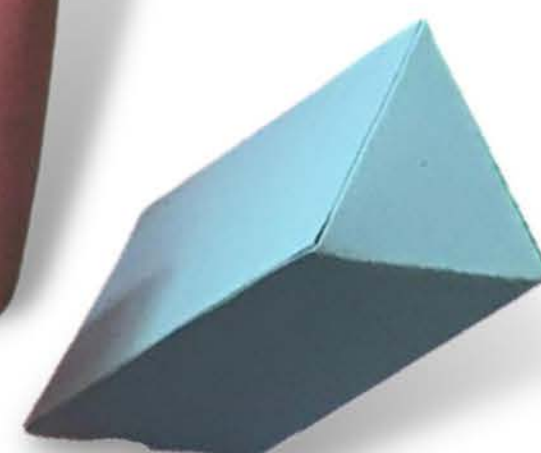
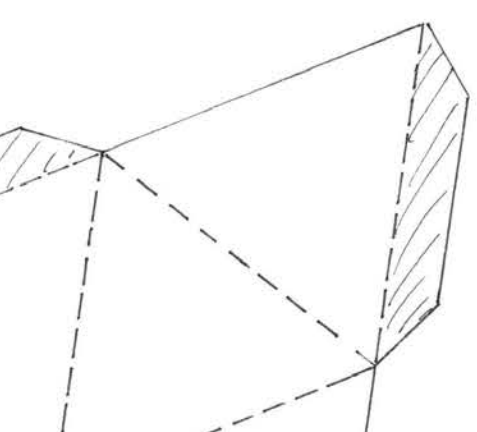
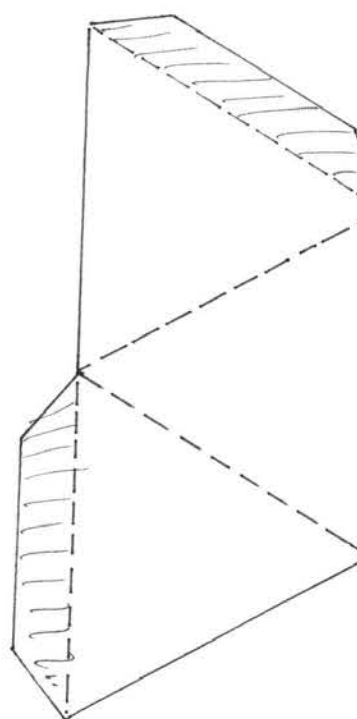

stick frames

STEP 1

Gather some sticks and arrange them in position to make your frame. This can be triangle, square or any other shape you want it to be.

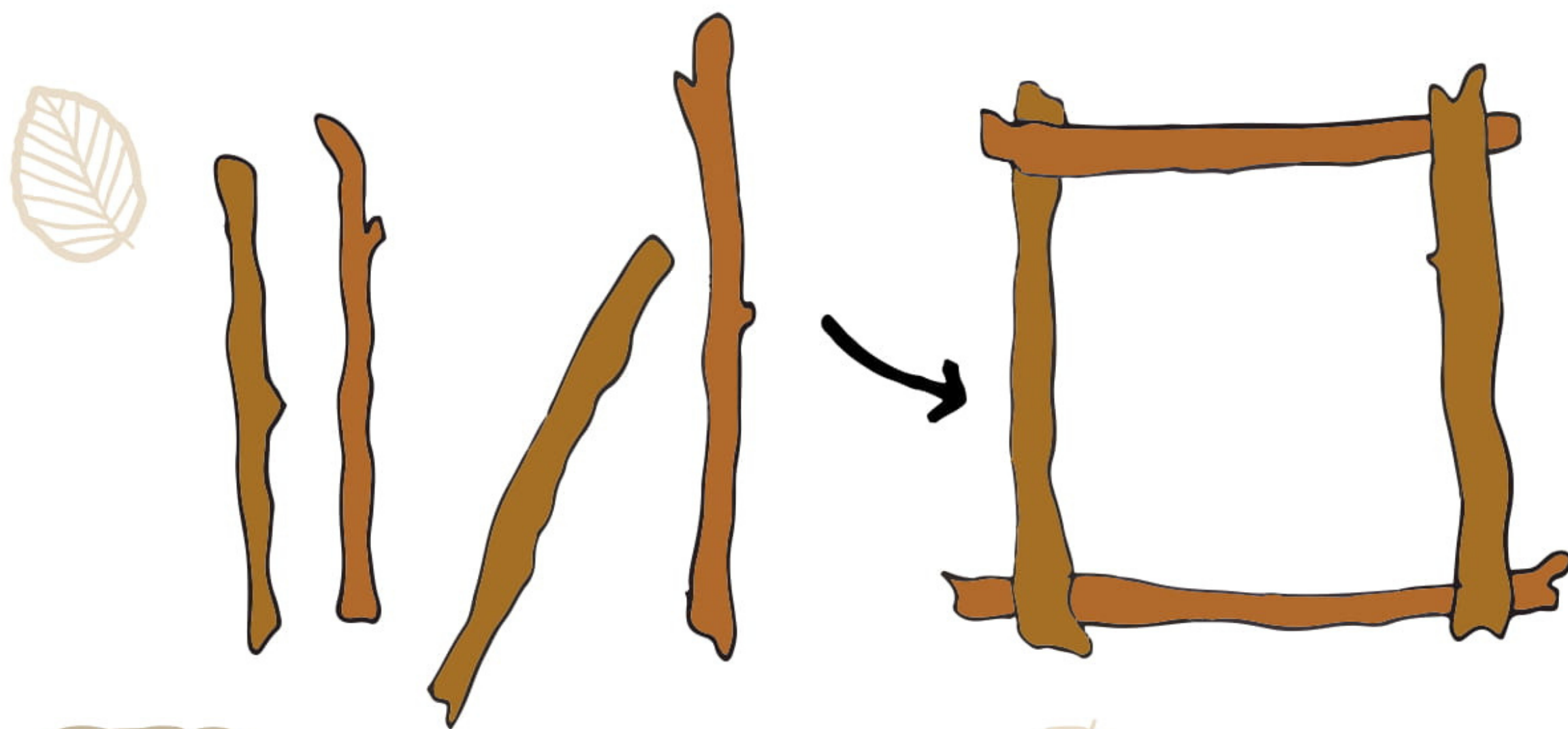

top tip!
tie
double knots
to make the
frame extra
strurdy

STEP 2

Using wool or brown string, tie your sticks together at the corners. (You can also use pipe cleaners for this instead.)

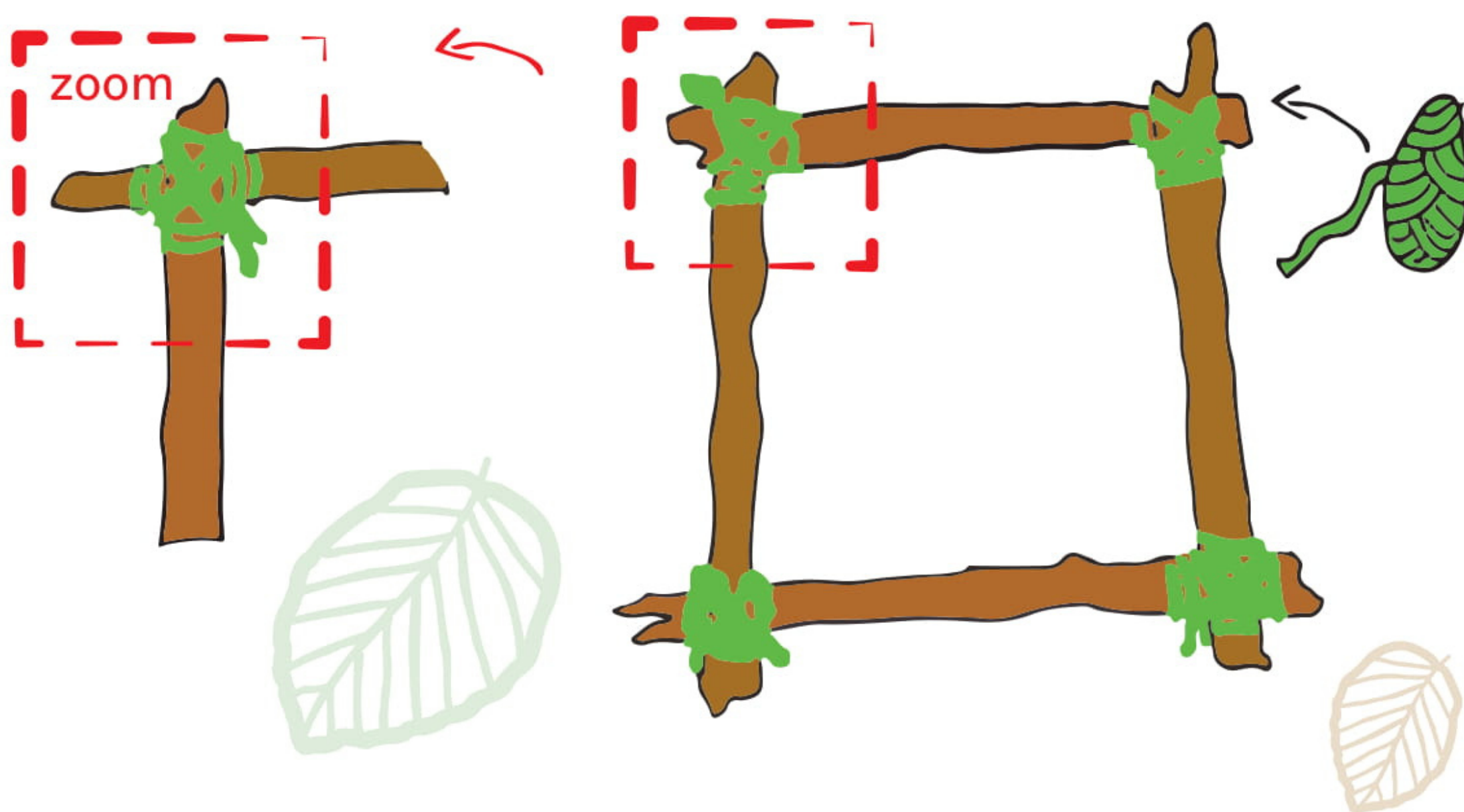

stick

frames

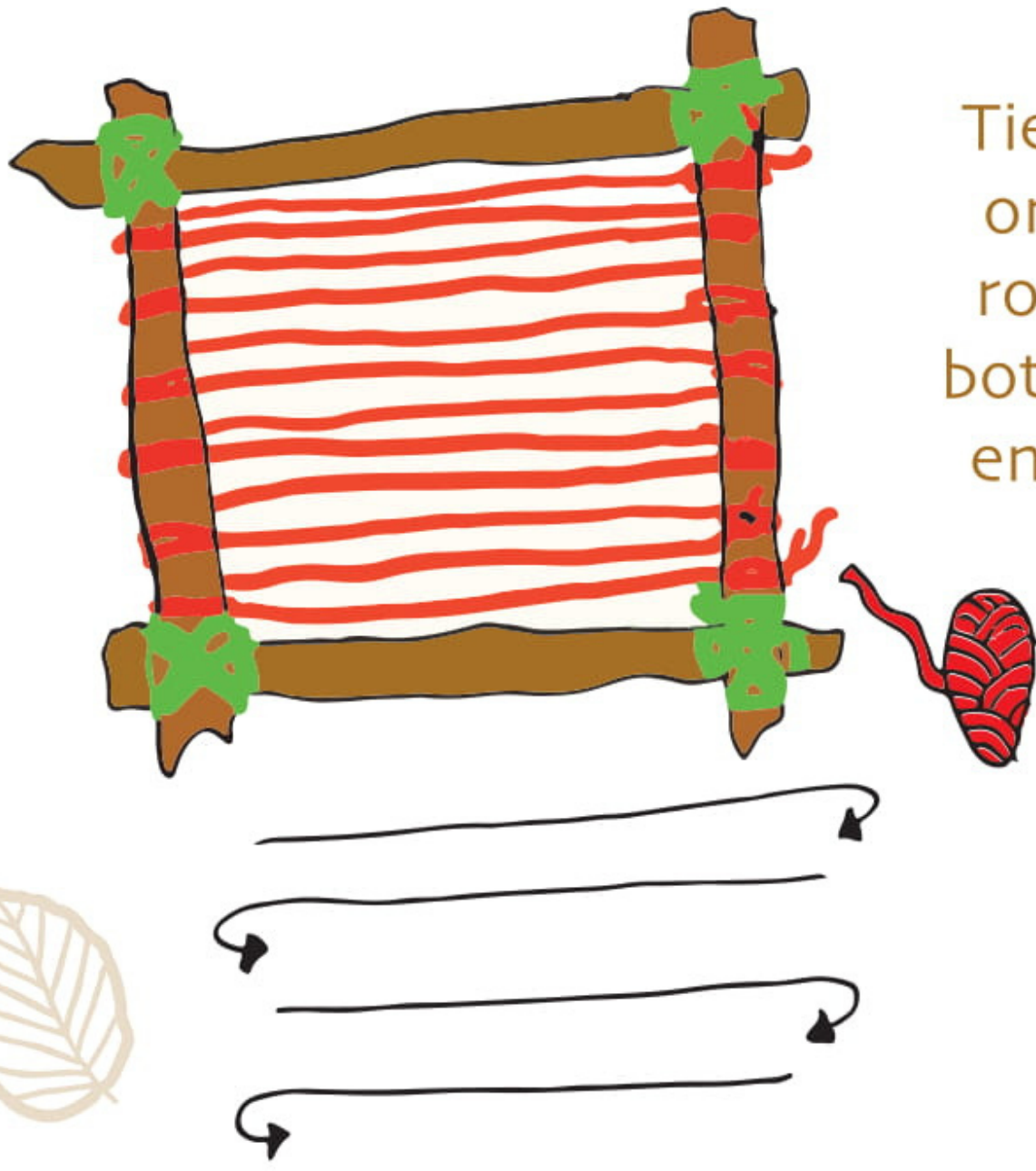

STEP 3

Tie on a new piece of wool or string close to one of the corners, then wrap it round and round the outside of the frame from top to bottom. Cut off the extra wool leaving a long enough piece to tie a knot at the bottom to finish the frame.

STEP 4

Decorate... go outside and gather leaves, plants, flowers, branches or you could try making decorations like the paper beads. Why not paint the sticks or leaves? If you weave the objects in between the string in an over under pattern they will stay in place.

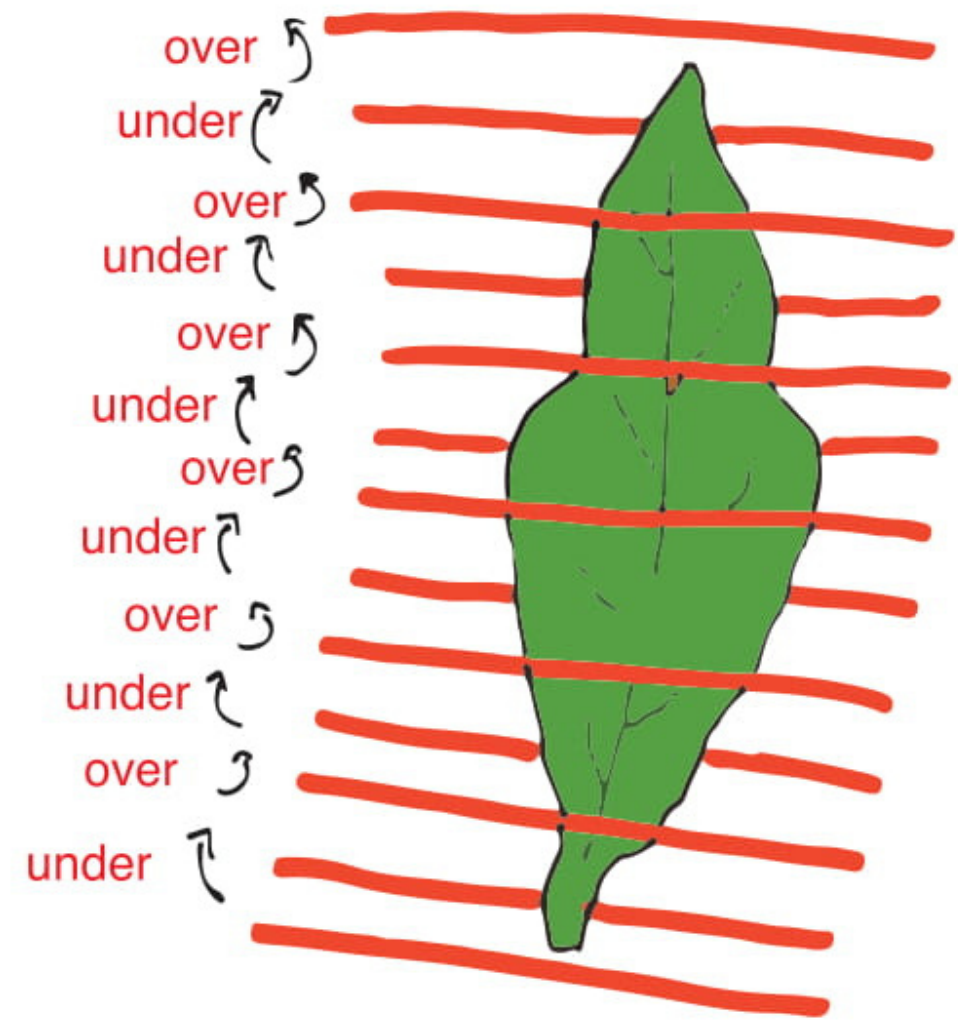

Ta-da!

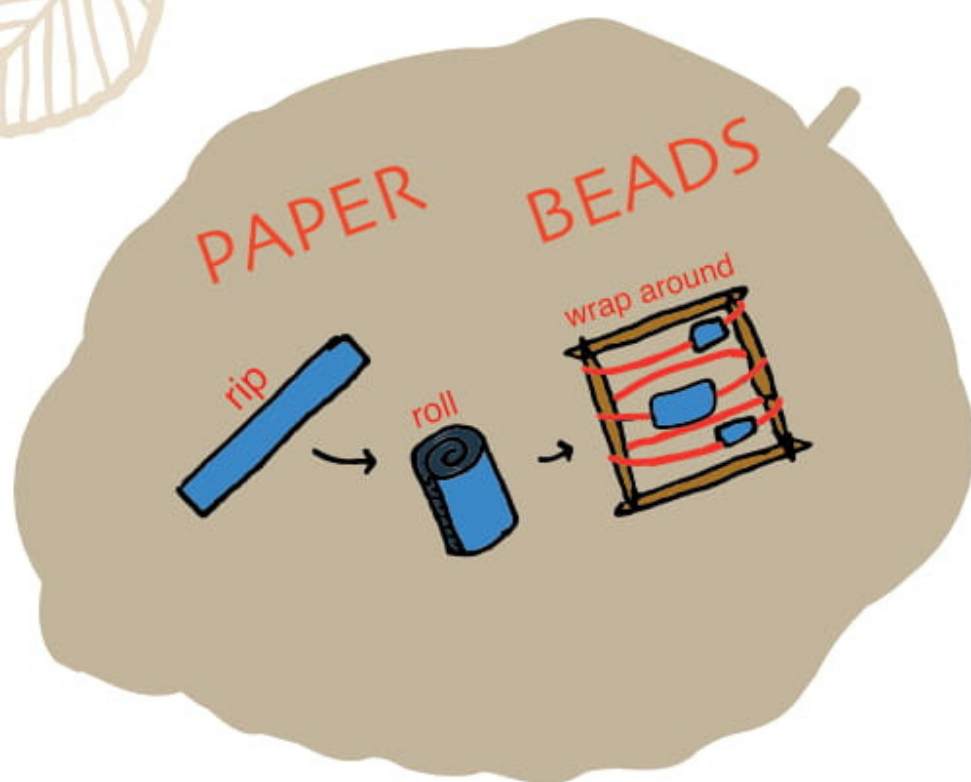

stick

frames

Triangle Frame



Mobile

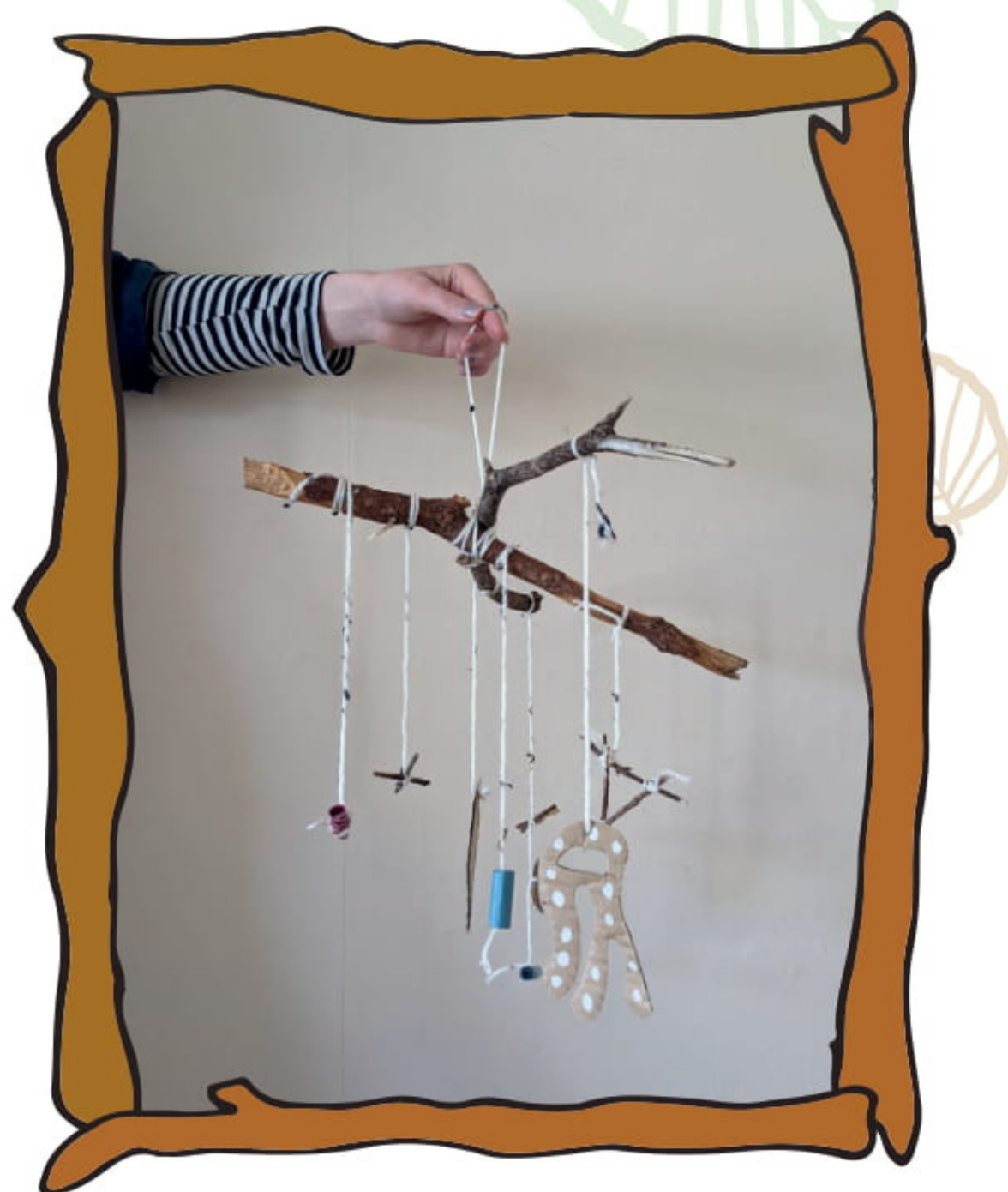

Recycled Cardboard Frame
(Try using part of your boredom box)



Woven Frame with Paper Beads



Draw what You See

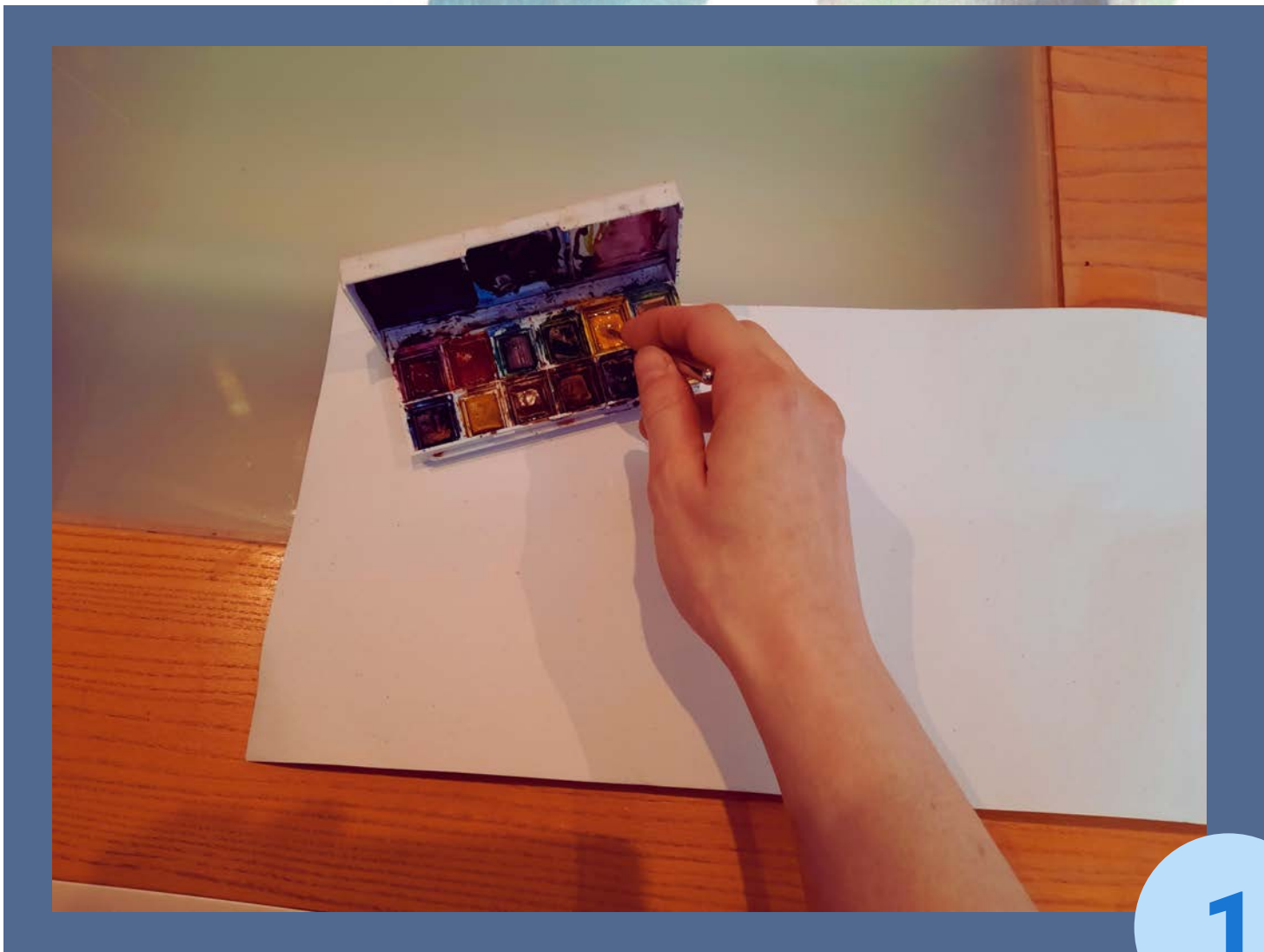

1

YOU WILL NEED

Sketchbook

Paint & Paint Brush

Fine liner pen

Cup of water

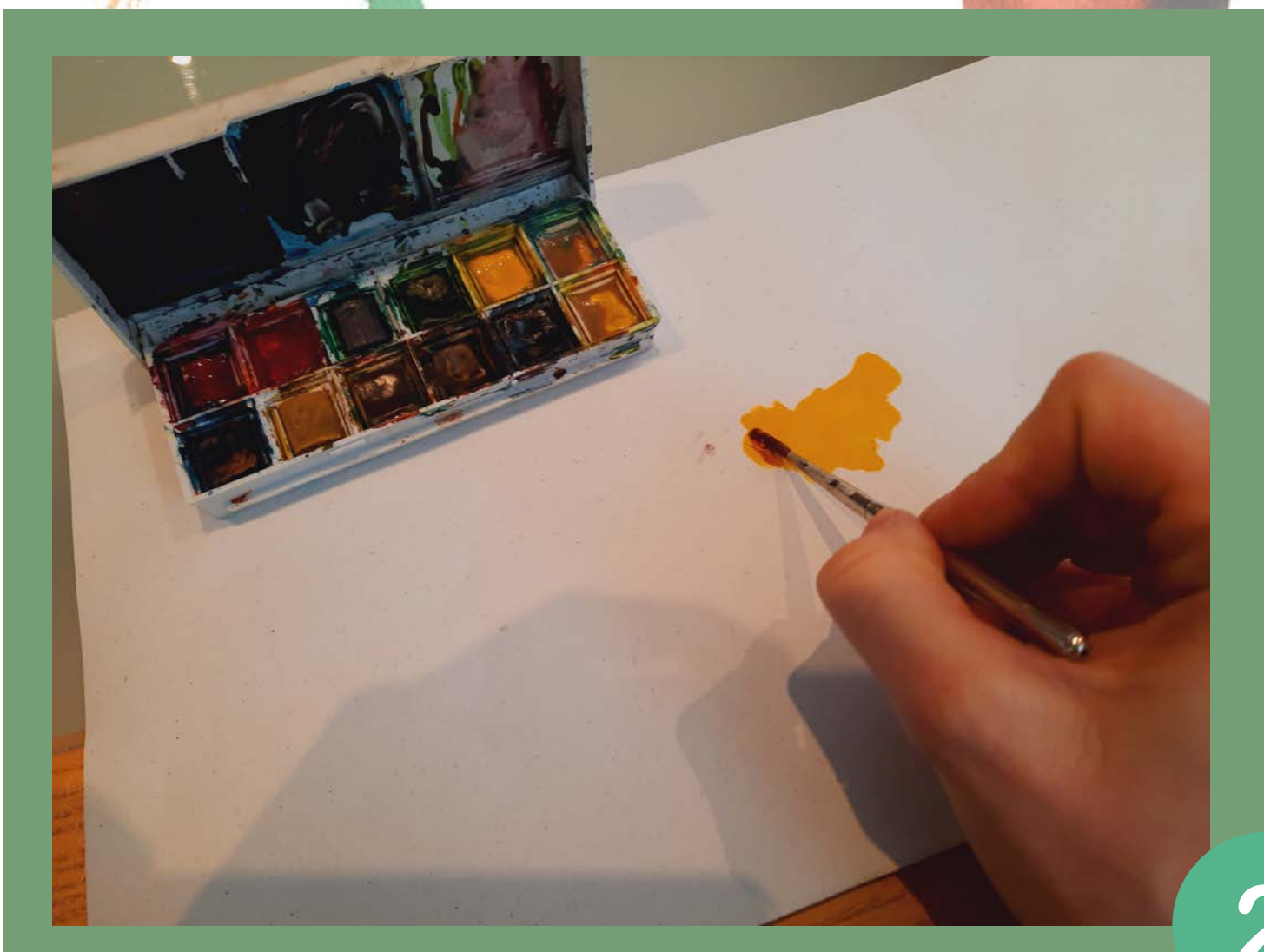

2

This is a fun and simple activity for all to enjoy, you just need to use your imagination and get creative!

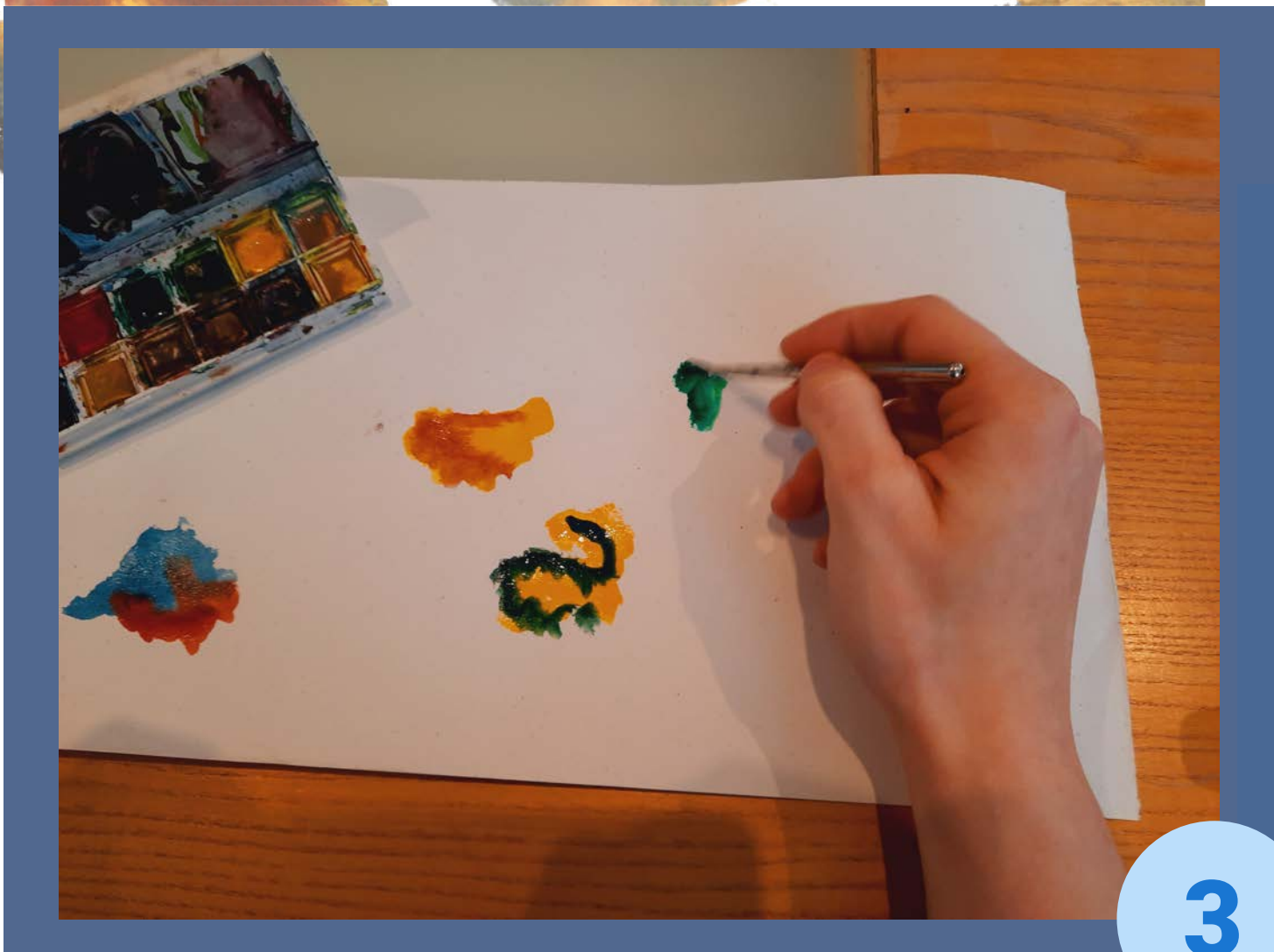

3

Grab your sketchbook, your paints and a paint brush, start by choosing your colours and painting random shapes and colours on to the paper.

4



Once you are happy with your results, be patient and allow the paint to dry.

Once you have allowed the paint to dry, have a look at your creations and discover hidden objects that have been accidentally created by your paint brush.

5



Now it's time to take your fine line pen and **DRAW WHAT YOU SEE!**

6



